

Configurable

Electr. 2-way PI-CCV Belimo Energy Valve™ fail-safe, AC/DC 24 V, BACnet IP, BACnet MS/TP, Modbus RTU, Modbus TCP, MP-Bus, DN 4"[100], Flange, ANSI Class 125, GPM 317



5-year warranty

Technical data

Electrical data	Nominal voltage	AC/DC 24 V	
	Nominal voltage frequency	50/60 Hz	
	Nominal voltage range	AC 19.2...28.8 V / DC 21.6...28.8 V	
	Power consumption in operation	17 W	
	Transformer sizing	29 VA	
Data bus communication	Communicative control	BACnet IP BACnet MS/TP Modbus RTU Modbus TCP MP-Bus	
	Functional data	Valve size [mm]	4" [100]
		Operating range Y	2...10 V
		Operating range Y note	4...20 mA w/ ZG-R01 (500 Ω, 1/4 W resistor)
		Input impedance	100 kΩ (0.1 mA), 500 Ω
Operating modes optional		VDC variable	
Position feedback U		2...10 V	
Position feedback U variable		VDC variable	
Running Time (Motor)		90 s	
Running time fail-safe		<35 s	
Sound power level Motor		52 dB(A)	
Noise level, fail-safe		61 dB(A)	
Control accuracy		±5%	
Min. controllable flow		1% of V ^{nom}	
Fluid	chilled or hot water, up to 60% glycol max (open loop/steam not allowed)		
Fluid Temp Range (water)	14...250°F [-10...120°C]		
Close-off pressure Δps	175 psi		
Differential Pressure Range	5...50 psi or 1...50 psi see flow reductions chart in tech doc		
Flow characteristic	equal percentage or linear		
Body Pressure Rating	ANSI Class 125, standard class B		
GPM	317		
Pipe connection	Flange for use with ASME/ANSI class 125		
Servicing	maintenance-free		
Manual override	external push button		

Technical data

Temperature measurement	Remote Temperature Sensor Length	Optional: 4.9 ft. [1.5m], 9.8 ft. [3m], 16.4 ft. [5m] Standard: 32.8 ft. [10m]
	<hr/>	
Flow measurement	Measuring accuracy flow	±2%*
	Measurement Repeatability	±0.5% (Flow)
	Sensor Technology	Ultrasonic with glycol and temperature compensation
<hr/>		
Safety data	Power source UL	Class 2 Supply
	Degree of protection IEC/EN	IP54
	Degree of protection NEMA/UL	NEMA 1
	Enclosure	UL Enclosure Type 1
	Agency Listing	cULus acc. to UL60730-1A/-2-14, CAN/CSA E60730-1:02 CE acc. to 2014/30/EU and 2014/35/EU
	Quality Standard	ISO 9001
	UL 2043 Compliant	Suitable for use in air plenums per Section 300.22(C) of the NEC and Section 602 of the IMC
	Ambient humidity	Max. 95% RH, non-condensing
	Ambient temperature	-22...122°F [-30...50°C]
	Storage temperature	-40...176°F [-40...80°C]
<hr/>		
Materials	Valve body	Cast iron - GG 25
	Flow measuring pipe	Ductile cast iron - GGG50
	Stem	stainless steel
	Stem seal	EPDM (lubricated)
	Seat	PTFE
	Characterized disc	stainless steel
	O-ring	EPDM (lubricated)
	Ball	stainless steel

Safety notes

- **WARNING:** This product can expose you to lead which is known to the State of California to cause cancer and reproductive harm. For more information go to www.p65warnings.ca.gov

Product features

- Application** Water-side control of heating and cooling systems for AHUs and water coils.
- Operation** The Energy Valve is an energy metering pressure independent control valve that measures, documents and optimises water coil performance.
- Flow measurement** *All flow tolerances are at 68°F [20°C] & water.

Accessories

Electrical accessories	Description	Type
	Replacement flow sensor for Belimo Energy Valve™, electromagnetic	EV FS-60
	Replacement temperature sensors for Belimo Energy Valve™, 65...150 1.5 m	EV-RT-15

Accessories

	Description	Type
	Replacement temperature sensors for Belimo Energy Valve™, 65...150 10 ft [3 m]	EV-RT-30
	Replacement temperature sensors for Belimo Energy Valve™, 65...150 16 ft [5 m]	EV-RT-50
	Replacement temperature sensors for Belimo Energy Valve™, 65...150 10 m	EV-RT-100
	Service tool, with ZIP-USB function, for programmable and communicative Belimo actuators, VAV controller and HVAC performance devices	ZTH US
Mechanical accessories	Description	Type
	Weather shield for Belimo Energy Valve™, 100...150, Ultrasonic models only	ZS-EPIV-EV-150U

Electrical installation

Wire colors:

- 1 = black
- 2 = red
- 3 = white
- 5 = orange
- 6 = pink
- 7 = grey

INSTALLATION NOTES

- Actuators with appliance cables are numbered.
- Actuators may be connected in parallel. Power consumption and input impedance must be observed.
- Actuators may also be powered by DC 24 V.
- Actuators with plenum cable do not have numbers; use color codes instead.
- Meets cULus requirements without the need of an electrical ground connection.
- Warning! Live electrical components!**
During installation, testing, servicing and troubleshooting of this product, it may be necessary to work with live electrical components. Have a qualified licensed electrician or other individual who has been properly trained in handling live electrical components perform these tasks. Failure to follow all electrical safety precautions when exposed to live electrical components could result in death or serious injury.

Conventional operation

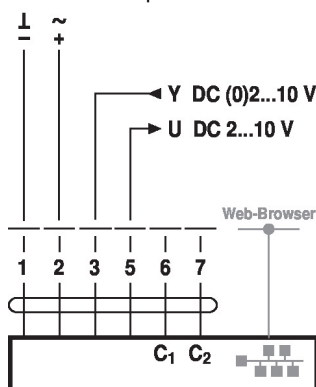
Cable colors:

- 1 = black
- 2 = red
- 3 = white
- 5 = orange
- 6 = pink
- 7 = grey

Dimensions

Dimensional drawings

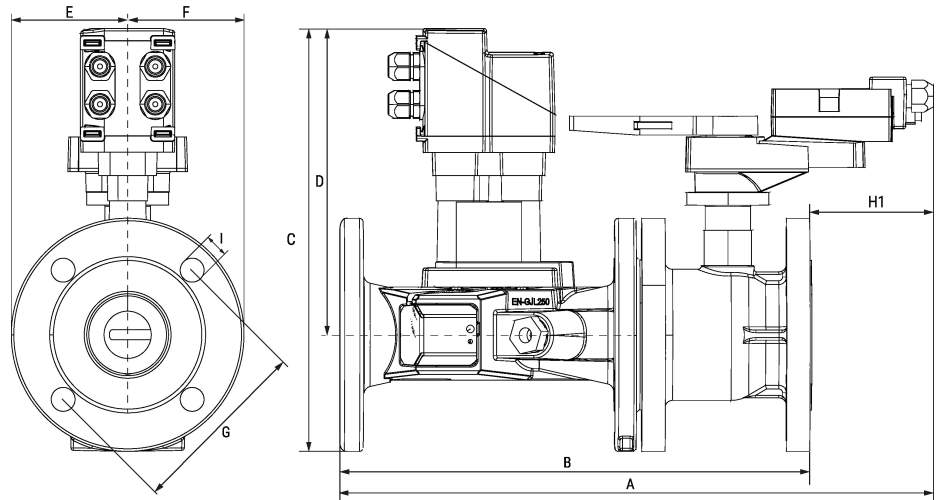

Type

EV400SU-317+GKRX24-EV

Weight

110 lb [50 kg]

A	B	C	D	E	F	G	H1	I	Number of Bolt Holes
20.5" [521]	18.7" [474]	13.9" [354]	9.9" [251]	4.5" [114]	4.5" [114]	7.5" [191]	1.8" [46]	0.7" [19]	8